

The Cognitive Cycle

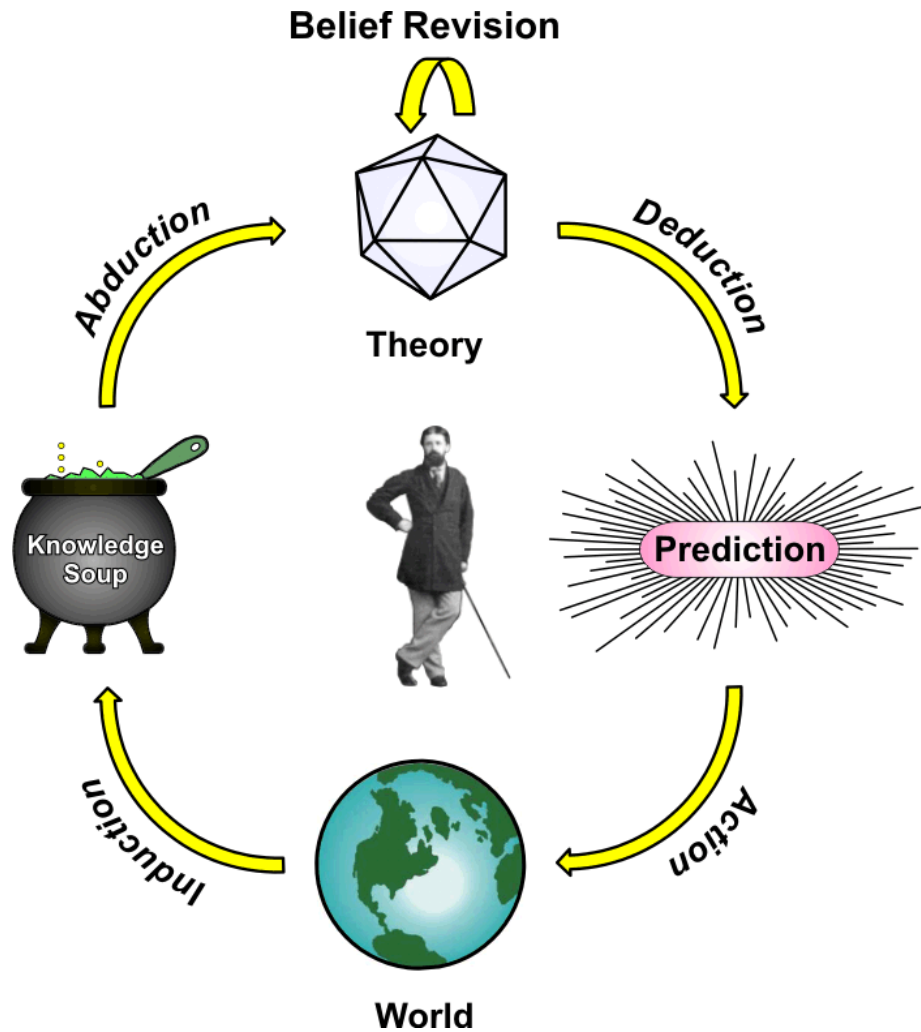

John F. Sowa
1 October 2015

Outline

1. Problems and Challenges for Artificial Intelligence

Why hasn't AI made more progress in the past 60 years? Have we been using the right tools? Theories? Methodologies?

2. Visualization in Language and Thought

The semantics of natural language is based on visual models. Every artificial notation, including logic, is an abstraction from language.

3. Hybrid Systems to Support an Open-Ended Diversity

New experiences rewire the brain for new ways of thinking. AI systems must be able to support and integrate that diversity.

4. Cycles of Learning and Reasoning

The cycle of pragmatism by C. S. Peirce links perception to all forms of learning, reasoning, and purposive action.

Click for [a YouTube presentation](#) of these slides or for [an article](#) on the same topic, but with more references.

1. Problems and Challenges

Early hopes for artificial intelligence have not been realized.

Language understanding is more difficult than anyone thought.

A three-year-old child is better able to learn, understand, and speak a language than any current computer system.

Tasks that are easy for many animals are impossible for the latest and greatest robots.

Questions:

- **Have we been using the right theories, tools, and techniques?**
- **Why haven't these tools worked as well as we had hoped?**
- **What other methods might be more promising?**
- **What can research in neuroscience and psycholinguistics tell us?**
- **Can it suggest better ways of designing intelligent systems?**

Early Days of Artificial Intelligence

- 1960:** Hao Wang's theorem prover took 7 minutes to prove all 378 FOL theorems of *Principia Mathematica* on an IBM 704 – much faster than two brilliant logicians, Whitehead and Russell.
- 1960:** Emile Delavenay, in a book on machine translation:
“While a great deal remains to be done, it can be stated without hesitation that the essential has already been accomplished.”
- 1965:** Irving John Good, in speculations on the future of AI:
“It is more probable than not that, within the twentieth century, an ultraintelligent machine will be built and that it will be the last invention that man need make.”
- 1968:** Marvin Minsky, a technical adviser for the movie *2001*:
“The HAL 9000 is a *conservative estimate* of the level of artificial intelligence in 2001.”

The HAL 9000

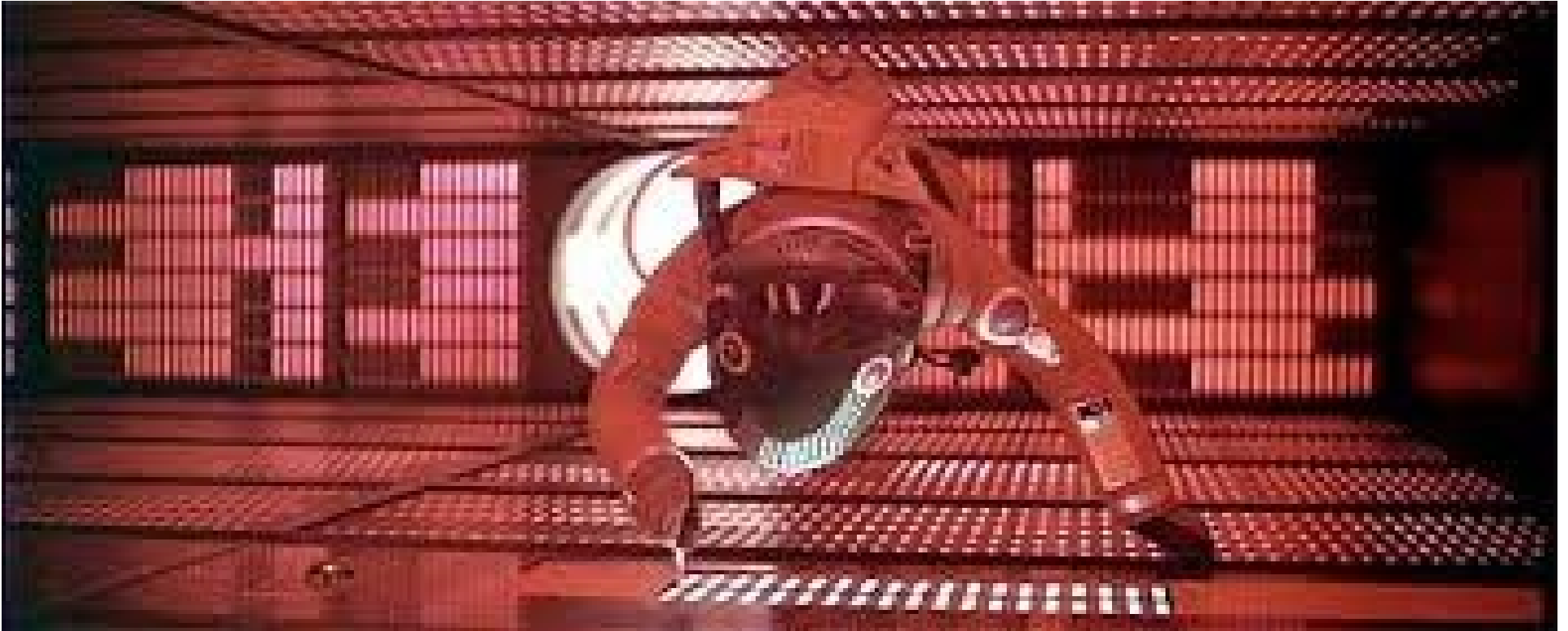

The advisers made two incorrect predictions:

- **Hardware technology developed faster than they expected.**
- **But software, including AI, developed much slower.**

Predicting a future invention is almost as hard as inventing it.

Google Books in the Year 2000?

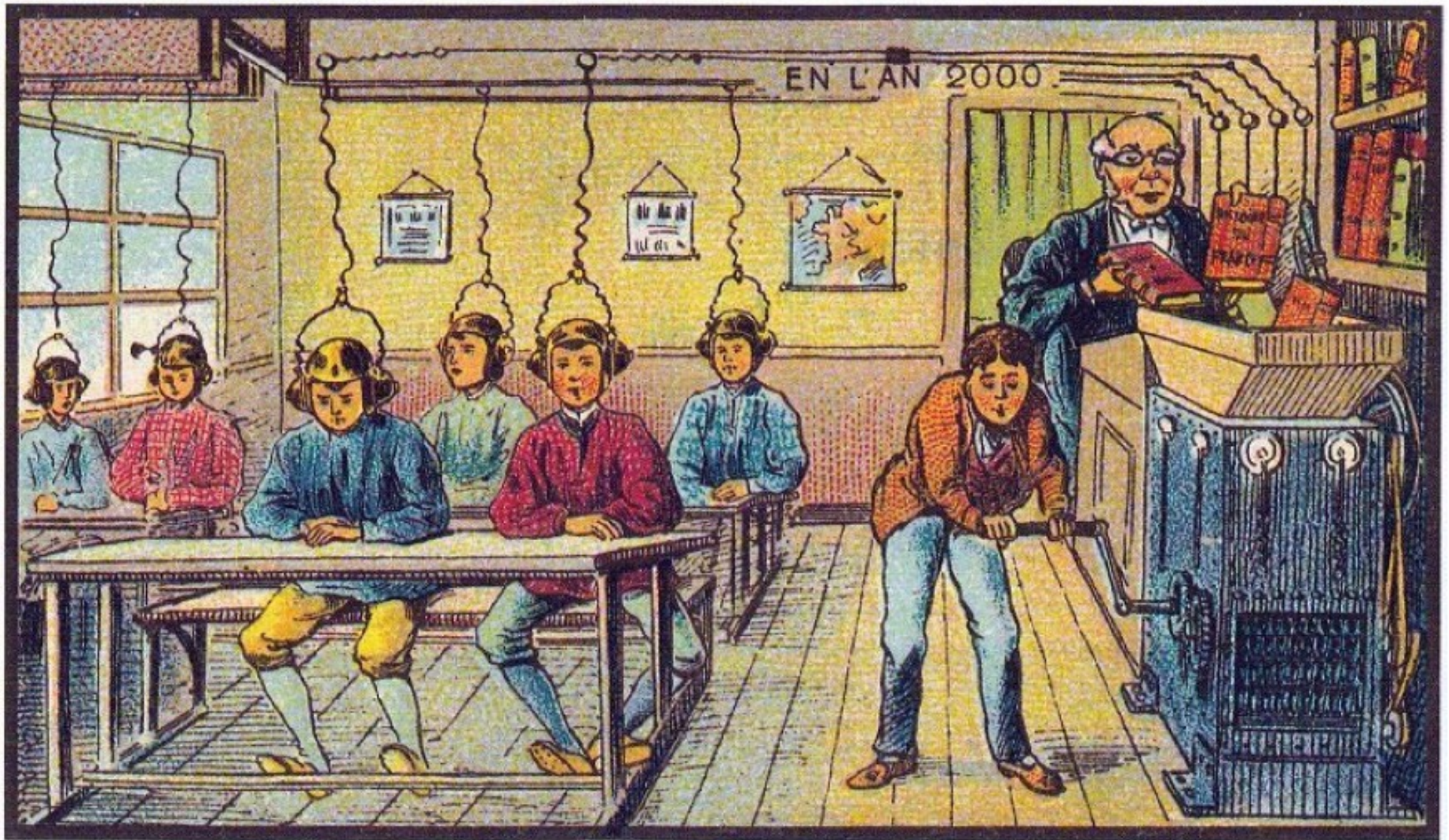

A classroom in 2000, as imagined in 1900 *

* <http://publicdomainreview.org/collections/france-in-the-year-2000-1899-1910/>

The Perceptron

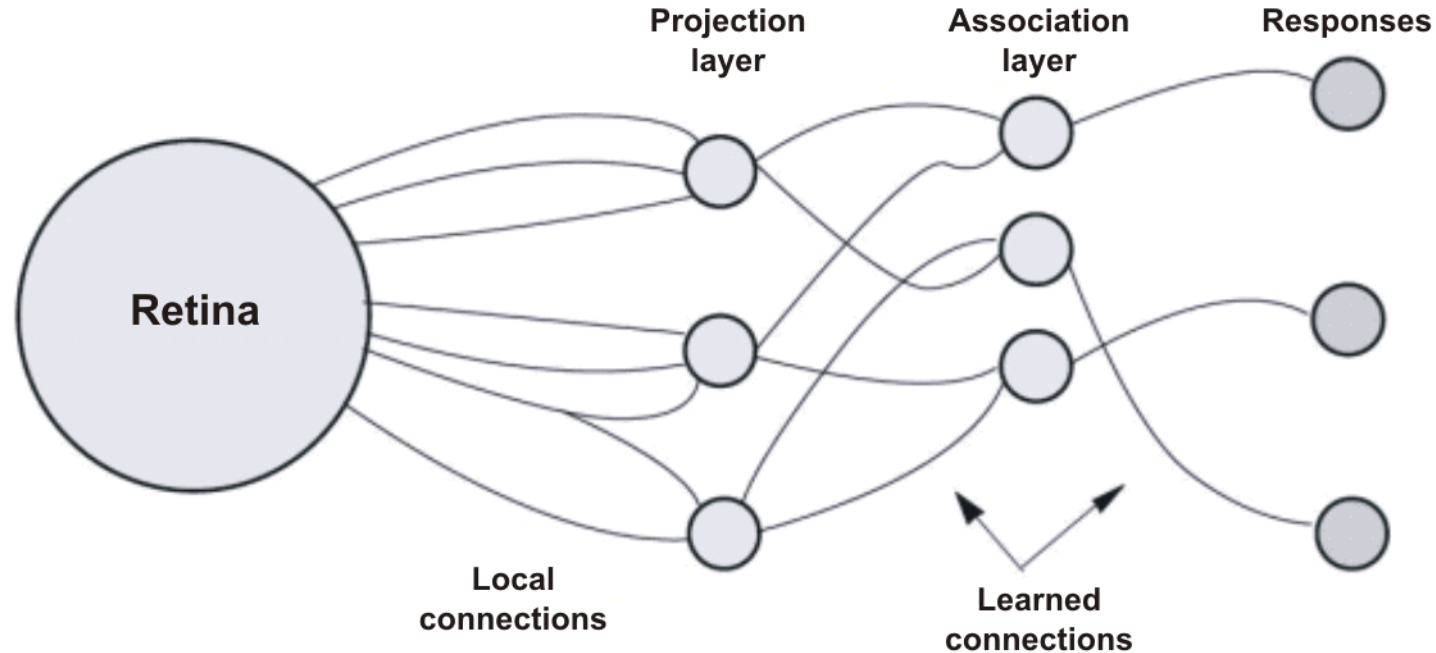

One-layer neural network invented by Frank Rosenblatt (1957).

Mark I: a hardware version funded by the US Navy:

- Input: 400 photocells in a 20 x 20 array.
- Weights represented by potentiometers, updated by electric motors.

After a press conference in 1958,

The New York Times reported the perceptron to be “the embryo of an electronic computer that [the Navy] expects will be able to walk, talk, see, write, reproduce itself and be conscious of its existence.”

A Breakthrough in Machine Learning



Program for playing checkers by Art Samuel in 1959:

- Ran on the IBM 704, later on the IBM 7090.
- The IBM 7090 was comparable in speed to the original IBM PC (1981), and its maximum RAM was only 144K bytes.

Samuel's program was a hybrid:

- A perceptron-like algorithm for learning to evaluate game positions.
- The alpha-beta algorithm for searching game trees.

Won a game against the Connecticut state checkers champion.

Bird Nest Problem

Robots can perform many tasks with great precision.

But they don't have the flexibility to handle unexpected shapes.

They can't wash dishes the way people do — with an open-ended variety of shapes and sizes.

And they can't build a nest in an irregular tree with irregular twigs, straw, and moss.

If a human guides a robot through a complex task with complex material, the robot can repeat the same task in the same way.

But it doesn't have the flexibility of a bird, a beaver, or a human.



Understanding Cartoons and Comics



Relatively easy: Parse the question and the answer.

Much harder: Find and use background knowledge in order to

- Recognize the situation type and the roles of the two agents,
- Relate the word 'thing' to the picture and to the concept Car,
- Determine what would be taken and how the car would move,
- Use elementary physics to understand the answer.

Major challenge: Understand the irony and the humor.

* Search for 'moving' at <http://www.shoecomics.com/>

Google Translate

Based on statistical methods for matching strings.

String matching is fairly good for short sentences:

English source: *The electrician is working.*

German: *Der Elektriker arbeitet.*

Polish: *Elektryk pracuje.*

English source: *The telephone is working.*

German: *Der Telefon funktioniert.*

Polish: *Telefon działa.*

But it can't keep track of long-distance connections: *

English source: *The electrician that came to fix the telephone is working.*

German: *Der Elektriker, der das Telefon zu beheben kam funktioniert.*

Polish: *Elektryk, który przyszedł naprawić telefon działa.*

English source: *The telephone on the desk is working.*

German: *Das Telefon auf dem Schreibtisch arbeitet.*

Polish: *Telefon na biurku pracuje.*

* Ernest Davis & Gary Marcus (2015) [Commonsense Reasoning and Knowledge in AI](#).

The Ultimate Understanding Engine

Sentences uttered by a child named Laura before the age of 3. *

Here's a seat. It must be mine if it's a little one.

I went to the aquarium and saw the fish.

I want this doll because she's big.

*When I was a little girl, I could go "geek geek" like that,
but now I can go "This is a chair."*

Laura used a larger subset of logic than Montague formalized.

**No computer system today can learn and use language as fast,
as accurately, and as flexibly as a three-year-old child.**

* John Limber, The genesis of complex sentences.

http://pubpages.unh.edu/~jel/JLimber/Genesis_complex_sentences.pdf

Cyc Project

The most ambitious attempt to build the HAL 9000:

- Cyc project founded by Doug Lenat in 1984.
- Starting goal: Implement the background knowledge of a typical high-school graduate.
- Ultimate goal: Learn new knowledge by reading textbooks.

After the first 25 years,

- 100 million dollars and 1000 person-years of work,
- 600,000 concepts,
- Defined by 5,000,000 axioms,
- Organized in 6,000 microtheories.

Some good applications, but more needs to be done:

- Cyc cannot yet learn by reading a textbook.
- Cyc cannot understand language as well as a child.

Multi-Layer Neural Nets

Deep Learning



Geoffrey Hinton: co-inventor of the backpropagation and contrastive divergence

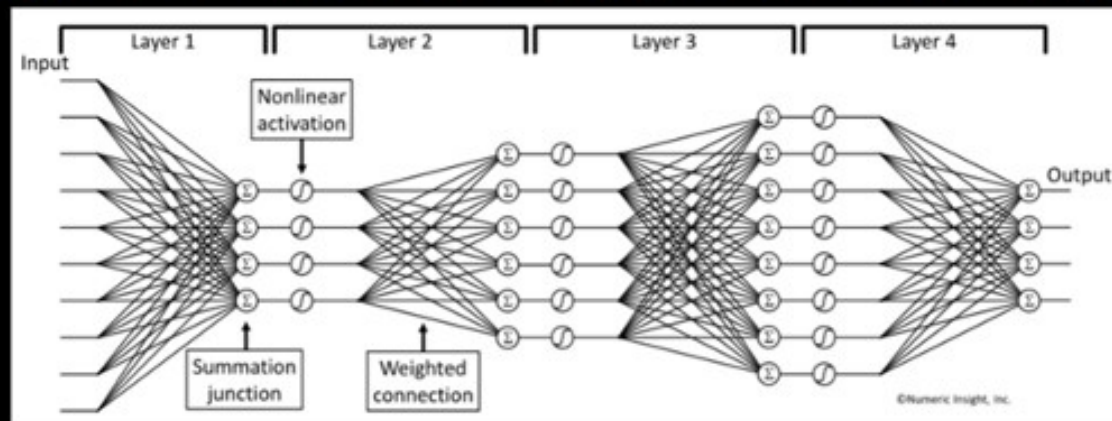

Biomimicry of the human cortex

Deep neural nets (DNNs) are much better than earlier versions. But they must be supplemented with other methods.

Learning to Play Games



Pong

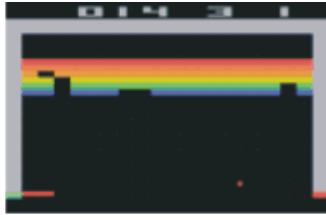

Breakout



Space Invaders

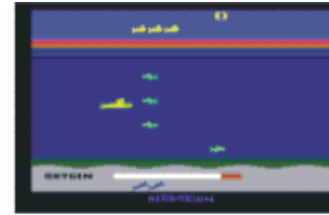

Seaquest



Beamrider

Using DNNs to learn how to play games for the Atari 2600: *

- Seven games: Pong, Breakout, Space Invaders, Seaquest, Beamrider, Enduro, and Q*bert.
- No prior knowledge about objects, actions, features, or game rules.
- Bottom layer starts with pixels: 210 x 160 video and the game score.
- Each layer learns features, which represent the data at the next layer.
- Top layer determines which move to make at each step of the game.

Shows that DNNs can be used to learn time-varying patterns.

* Mnih et al. (2013) at DeepMind Technologies, <http://www.cs.toronto.edu/~vmnih/docs/dqn.pdf>¹⁵

Developments at DeepMind

Good for pattern recognition, but a hybrid system is better.

Results on the Atari games:

- **Outperforms all other machine-learning methods on 6 of the 7 games.**
- **Better than a human expert on Breakout, Enduro, and Pong. Close to human performance on Beamrider.**
- **But far from human performance on Q*bert, Seaquest, and Space Invaders – because those games require long-term strategy.**

Comparison with Samuel's checker-playing system:

- **Modern DNNs are much more powerful than a perceptron.**
- **But Samuel's system was a hybrid.**
- **His learning method was adequate for its purpose.**
- **For long-term strategy, alpha-beta search is more human-like.**
- **A very deep search, if possible, could play a perfect game.**
- **But even a shallow search is more powerful than a DNN by itself.**
- **Conclusion: DNNs are useful, but more is needed.**

Active Learning

For DNNs, relating different views is not easy. *

- **Omission errors:** A photograph has an enormous amount of detail, but maps and drawings contain only a tiny fraction of the data.
- **Registration errors:** The geometry of drawings and diagrams is never as precise as a photograph.

For learning by mammals and birds, anticipation is fundamental:

- **Prior knowledge enables faster, more accurate perception.**
- **Goals and expectations are critical for guiding a search.**

Active machine learning uses knowledge from any source. **

- **Different aspects of a pattern are significant for different purposes.**
- **Animals constantly shift their attention from one aspect to another.**
- **Memory, reasoning, and data from language are valuable resources.**
- **Purpose and value are critical for directing attention.**

* <http://www.cs.toronto.edu/~hinton/>

** <http://burrsettles.com/pub/settles.activelearning.pdf>

2. Visualization in Language and Thought

Mental models are more fundamental than language or logic.

- **Meanings expressed in language are based on perception.**
- **Thinking and reasoning are based on mental models that use the same mechanisms as perception and action.**
- **The notations of mathematics and logic are abstractions from the symbols and patterns in natural languages.**

Computers can manipulate symbols faster than any human.

- **But they are much less efficient in perception and action.**
- **That limitation makes them unable to process language in the same way that people do.**

How could language, reasoning, and vision be integrated?

American Sign Language



MANY

DEAF

LEARN

AGENT



ENTER



SPEAK



COLLEGE

Many deaf students enter hearing colleges.

**The order of signs in ASL is similar to English word order.
But many syntactic features are absent; others are different.**

Diagram adapted from Lou Fant (1983) *The American Sign Language Phrase Book*.

Spoken and Signed Language

The same neural mechanisms are used to produce and interpret spoken and signed languages. (Petitto 2005)

Studies of bilingual infants of parents with different languages:

- **All pairs of four languages: English, French, American Sign Language (ASL), and Langue des Signes Québécoise (LSQ).**
- **Monolingual and bilingual babies go through the same stages and at the same ages for both spoken and signed languages.**
- **Hearing babies born to profoundly deaf parents babble with their hands, but not vocally.**
- **Babies bilingual in a spoken and a signed language babble in both modalities – vocally and with their hands.**
- **And they express themselves with equal fluency in their spoken and signed language at every stage of development.**

Petitto's conclusion: Any hypothesis about a Language Acquisition Device (LAD) must be independent of modality.

Spatio-Temporal Syntax

Signed and spoken languages have a time-ordered sequence.

But signed languages take advantage of 3-D space:

- **For anything visible, pointing serves the role of pronouns.**
- **But references to people and things that left the scene are also possible by pointing to where they had been.**
- **The signer can also introduce new characters and things, place them in fixed locations in the air, and refer to them by pointing.**
- **For spatial relations, signing is more “natural” than spoken language.**

Observation: The index finger is the most natural indexical.

Some theoretical questions:

- **Must a language of thought include geometry of the environment?**
- **If so, should it still be called a “language” of thought?**
- **A better term might be “cognitive map” or “mental model.”**

Visualization in Mathematics

Paul Halmos, mathematician:

“Mathematics — this may surprise or shock some — is never deductive in its creation. The mathematician at work makes vague guesses, visualizes broad generalizations, and jumps to unwarranted conclusions. He arranges and rearranges his ideas, and becomes convinced of their truth long before he can write down a logical proof... the deductive stage, writing the results down, and writing its rigorous proof are relatively trivial once the real insight arrives; it is more the draftsman’s work not the architect’s.” *

Albert Einstein, physicist:

“The words or the language, as they are written or spoken, do not seem to play any role in my mechanism of thought. The psychical entities which seem to serve as elements in thought are certain signs and more or less clear images which can be *voluntarily* reproduced and combined... The above-mentioned elements are, in my case, of visual and some of muscular type. Conventional words or other signs have to be sought for laboriously only in a secondary stage, when the mentioned associative play is sufficiently established and can be reproduced at will.” **

* Halmos (1968). ** Quoted by Hadamard (1945).

Archimedes' Eureka Moment



Insight: A submerged body displaces an equal volume of water.

- It's a mathematical principle, a property of Euclidean space.
- Scientists and engineers have used it ever since.
- They don't prove it. They use it to define *incompressible fluid*.

Determining the Value of π

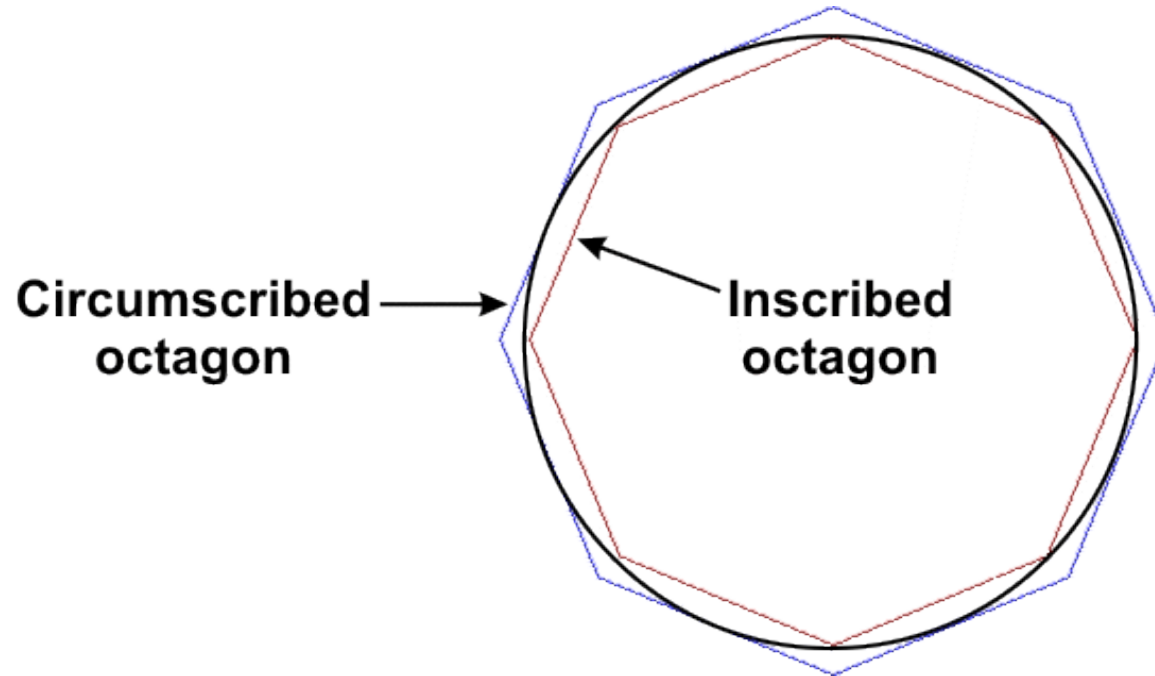

Archimedes had two creative insights:

- **The circumference of the circle is greater than the perimeter of the inner polygon and less than that of the outer polygon.**
- **As the number of sides increases, the inner polygon expands, and the outer polygon shrinks. They converge to the circle.**

Given these insights, a good mathematician could compute π to any desired precision. Archimedes used 96-gons.

Euclid's Proposition 1

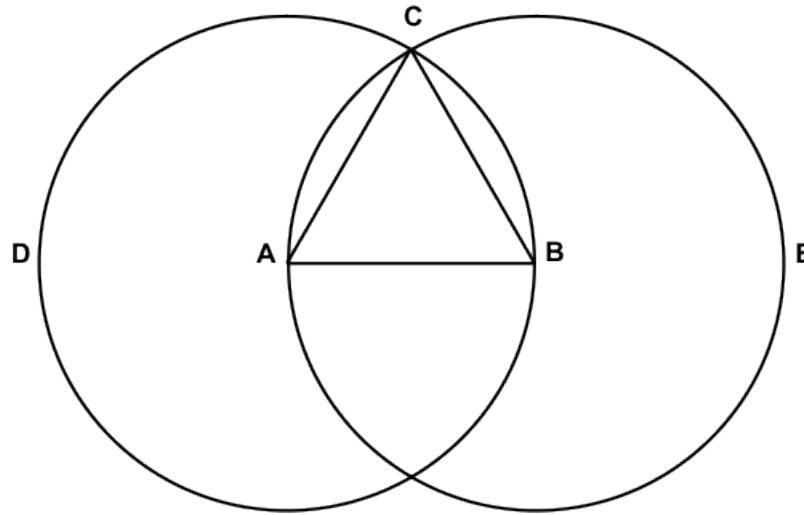

Euclid's statement, as translated by Thomas Heath:

- **On a given finite straight line, to draw an equilateral triangle.**

The creative insight is to draw two circles:

- **The circle with center at A has radii AB and AC.**
- **The circle with center at B has radii BA and BC.**
- **Since all radii of a circle have the same length, the three lines AB, AC, and BC form an equilateral triangle.**

Games of Go and Go-moku

Same syntax, but very different strategy:

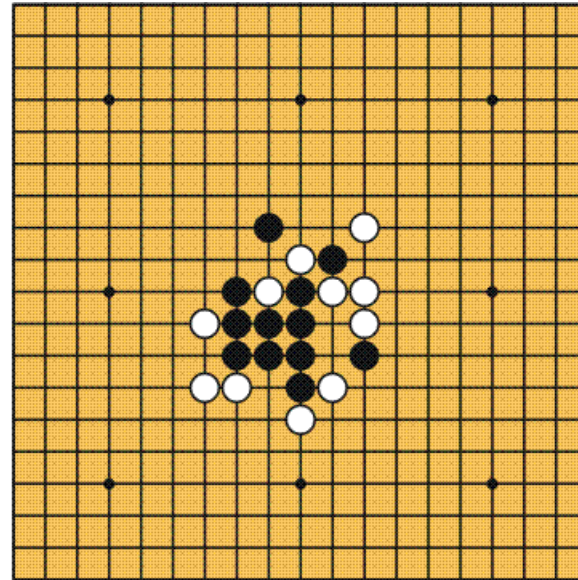
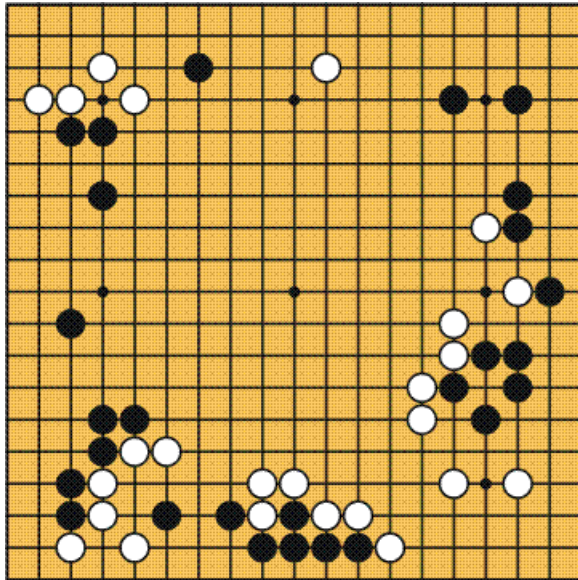

**Syntax defines legal moves, but not meaningful moves.
The meaning of any move is determined by its purpose.
In go, the goal is to place stones that surround territory.
In go-moku, the goal is to place five stones in a row.
Different goals change the strategy from the first move.**

3. Hybrid Systems to Support Diversity

Flexibility and generality are key to intelligence.

- The languages of our stone-age ancestors can be adapted to any subject: science, technology, business, law, finance, and the arts.
- When people invent anything, they find ways to describe it.
- When people in any culture adopt anything from another culture, they borrow or adapt words to describe it in their native language.

Minsky's proposal: A society of heterogeneous agents:

“What magical trick makes us intelligent? The trick is that there is no trick. The power of intelligence stems from our vast diversity, not from any single, perfect principle. Our species has evolved many effective although imperfect methods, and each of us individually develops more on our own. Eventually, very few of our actions and decisions come to depend on any single mechanism. Instead, they emerge from conflicts and negotiations among societies of processes that constantly challenge one another.” *

* Marvin Minsky (1986) *The Society of Mind*, New York: Simon & Schuster, §30.8.
See also Push Singh & Marvin Minsky (2004) [An architecture for cognitive diversity](#).

Take Advantage of Available Tools

Sixty years of R & D in AI and machine translation.

Tools and resources for a wide variety of paradigms:

- **Parsers and translators for natural and artificial languages.**
- **Grammars, lexicons, ontologies, terminologies, corpora, Wikipedia, DBpedia, Linked Open Data, and the Semantic Web.**
- **Theorem provers and inference engines for formal logic and many kinds of informal and fuzzy reasoning.**
- **Qualitative, case-based, and analogical reasoning.**
- **Statistical, connectionist, and neural network methods.**
- **Pattern recognition, data mining, and graph data mining,**
- **Genetic algorithms and machine-learning methods.**
- **Thousands of implementations of all the above.**

But most systems are designed around a single paradigm — they cannot take advantage of all the available resources.

Stanford NLP Group

Developing statistical-symbolic hybrids. *

- Statistical methods for computing parse trees.
- DNNs for recognizing images, parse trees for images, and parse trees for language that describes the images.
- Statistical methods for representing word meaning in vectors and semantic graphs that relate the vectors.
- Logical inferences to derive the implications.
- Methods for translating texts to graphs, generating visual scenes from the graphs, and using the scenes for retrieving images.

Hybrid methods have produced promising results.

But more research is needed to generalize and systematize the methods for relating heterogeneous paradigms.

* <http://nlp.stanford.edu/publications.shtml>

Parsing Natural Scene Images

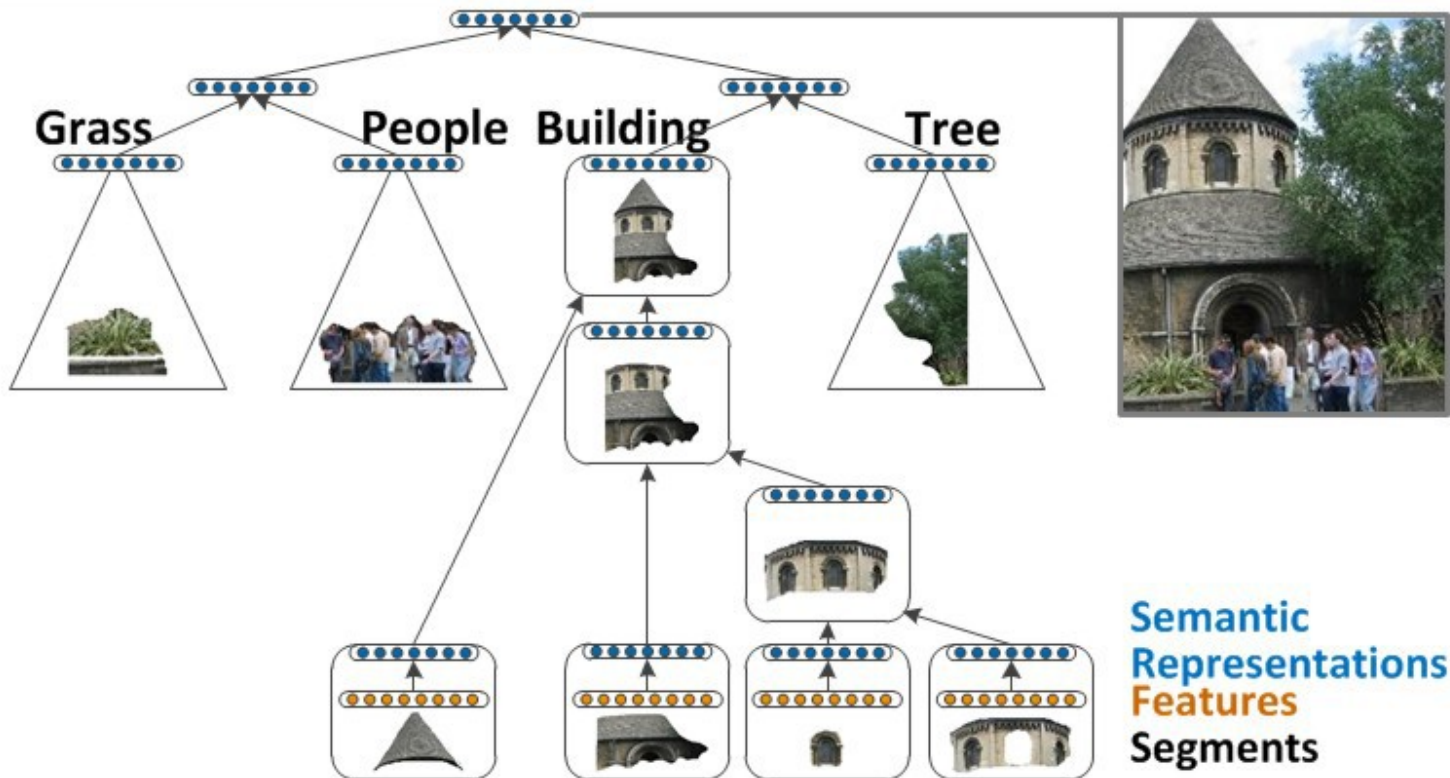

Parsing Natural Language Sentences

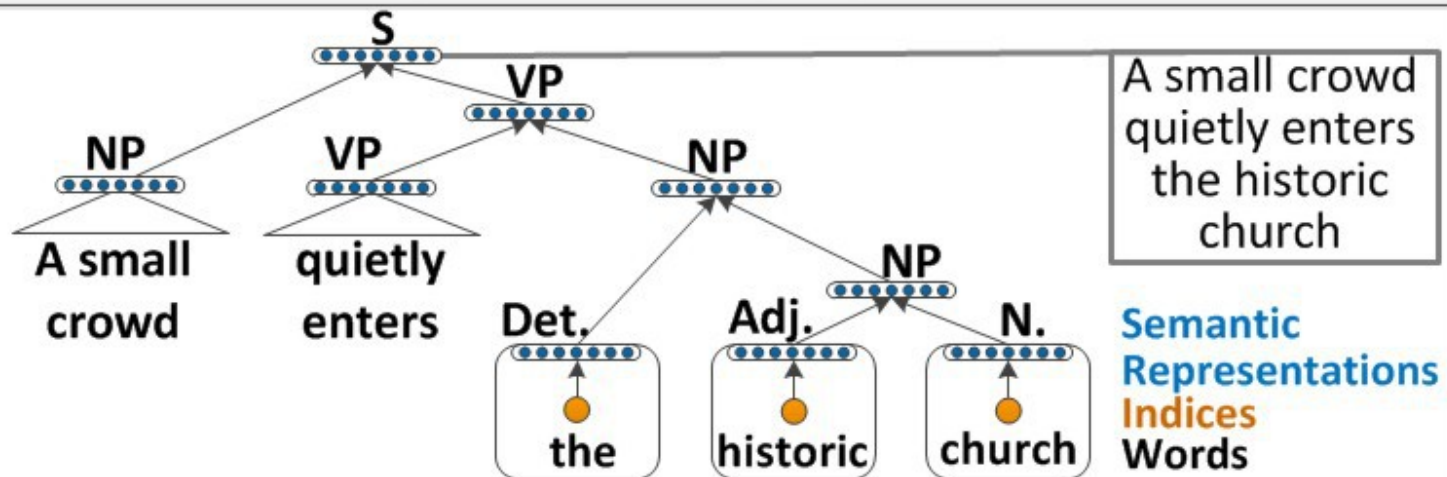

Geometry Problem Solver (GeoS)

In the figure to the left, triangle ABC is inscribed in the circle with center O and diameter AC. If $AB=AO$, what is the degree measure of angle ABO?

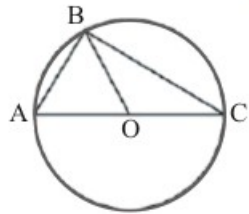

- (A) 15°
- (B) 30°
- (C) 45°
- (D) 60°
- (E) 90°



In the figure to the left, CDE is an equilateral triangle and ABCE is a square with an area of 1. What is the perimeter of polygon ABCDE?

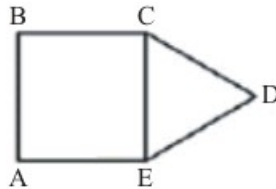

- (A) 4
- (B) 5
- (C) 6
- (D) 7
- (E) 8



GeoS solves typical problems on the Geometry SAT exam. *
It's a hybrid that uses visual information to help parse the questions.

* Developed by the [Allen Institute for AI](#) and the [University of Washington](#).

Learning Language as a Child

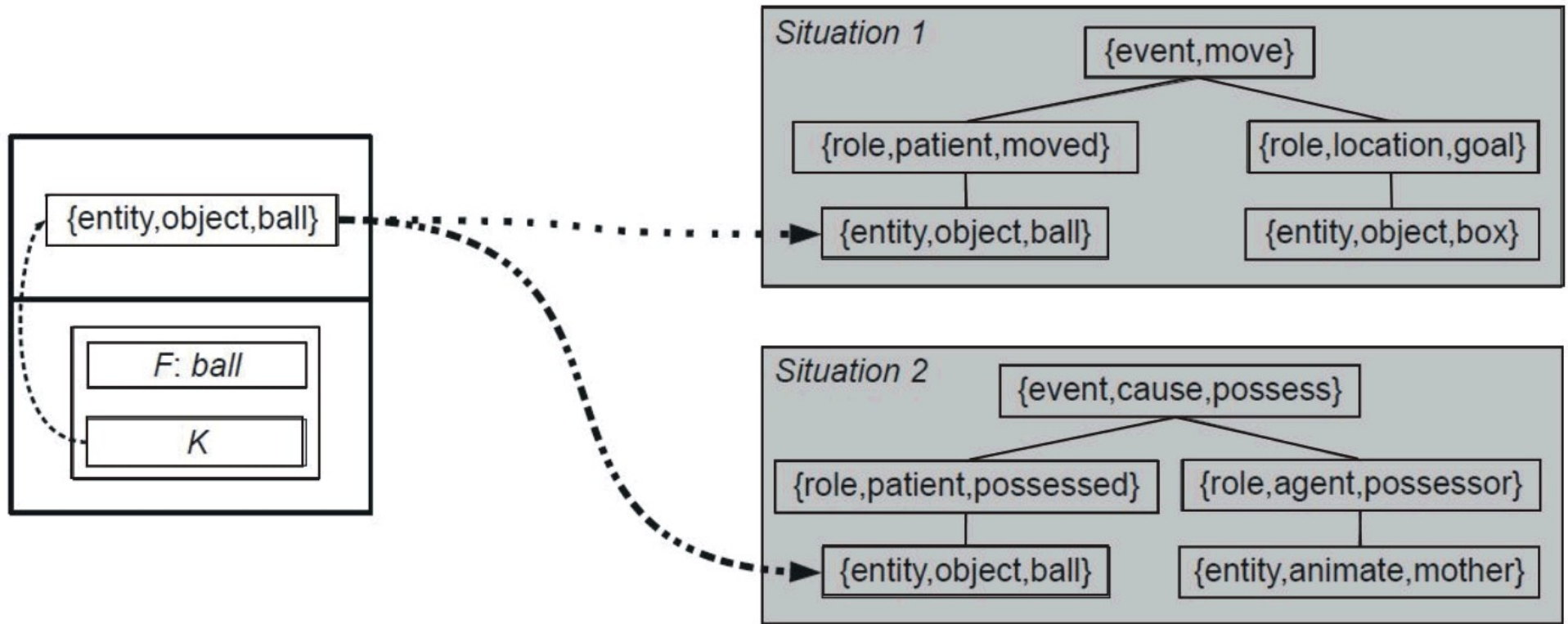

Syntagmatic-Paradigmatic Learner (SPL). *

- Learns to map language to and from discourse situations.
- The box on the left represents the word *ball*, which was spoken in the two situations described by the boxes on the right.

* Designed by Barend Beekhuizen (2015), *Constructions Emerging*, [PhD dissertation](#).

Learning to Map Language to Situations

SPL learns to relate strings of words to discourse situations:

- **The notation is based on Langacker's theory of cognitive grammar.**
- **SPL is trained with strings of words paired with diagrams of relevant situations (as in the diagram in the previous slide).**
- **In the early stages, SPL learns to map single words to appropriate nodes of a situation description.**
- **Later, it maps two-word and multi-word constructions of words to larger subgraphs of the situation descriptions.**
- **It also learns reverse mappings from situations to strings of words.**
- **Appropriate rewards train SPL to learn correct mappings.**

Theory and implementation:

- **SPL is consistent with a wide range of psycholinguistic studies.**
- **The implemented version learns to map sentence patterns to and from graphs that describe situations,**
- **To enable a robot to learn language, more work is needed to combine SPL with a speech recognizer and a visual pattern recognizer.**

Evidence from Neuroscience

The regions of the cerebral cortex are highly specialized.

A study with fMRI scans showed which regions are active at different stages of learning. *

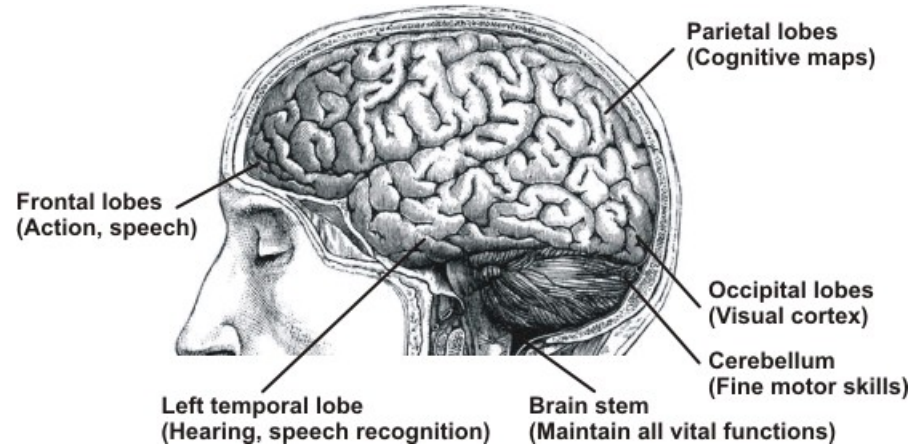

16 participants studied how four devices work: bathroom scale, fire extinguisher, automobile braking system, and trumpet.

For all participants, learning progressed through four stages:

1. Visual cortex was active in recognizing the shapes and details.
2. Parietal lobes became active in learning the mechanical structures.
3. All lobes became active as participants were “generating causal hypotheses” about how the system worked.
4. Finally, the frontal cortex was anticipating “how a person (probably oneself) would interact with the system.”

* R. A. Mason & M. A. Just (2015) <http://medicalxpress.com/news/2015-03-science-brain.html>

The Brain in Language Learning

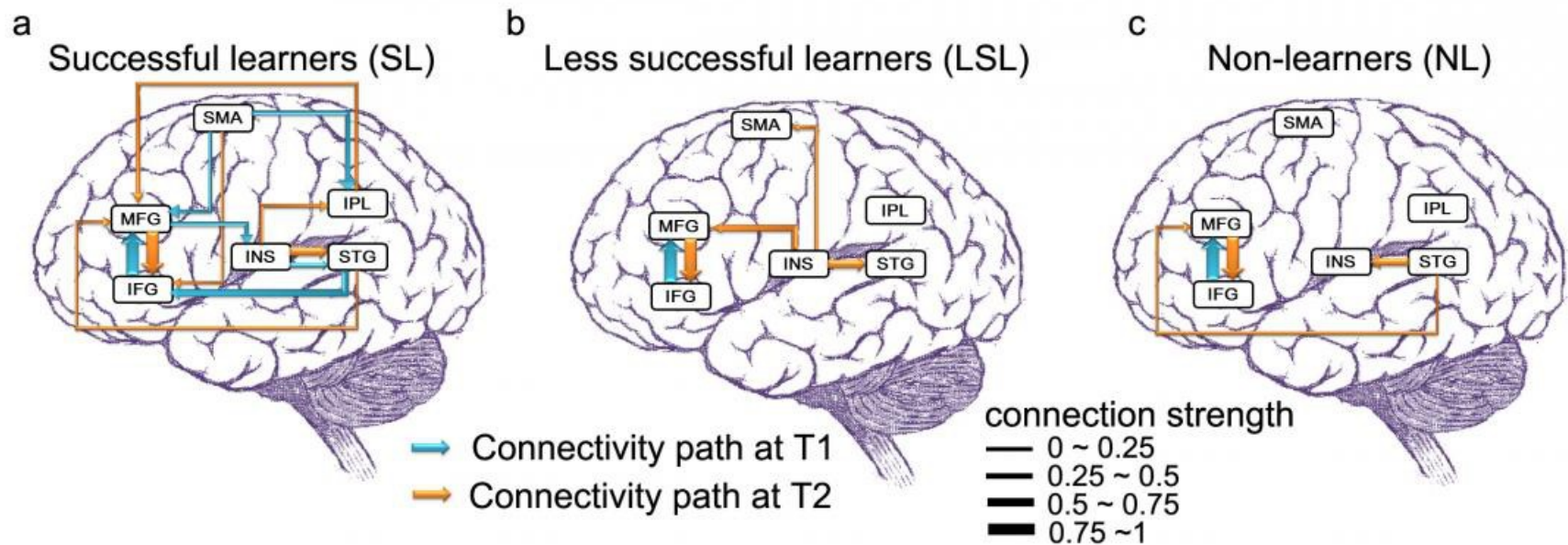

Language learning increases connectivity among brain regions.

- 39 native English speakers studied Chinese for 6 weeks. *
- fMRI scans showed an increase in connectivity in successful learners compared to less successful learners.
- Those who learned the fastest had more connectivity at the start.

Learning a new language, natural or artificial, rewires the brain.

* Ping Li (2014) <http://medicalxpress.com/news/2014-11-languages-workout-brains-young.html>

Case Study: Cyc and IBM Watson

Why did IBM, not Cyc, beat the Jeopardy! champion?

Short answer: Cyc was not designed for game shows.

- Cyc was designed to represent the general knowledge of a typical high-school student.
- A high-school education isn't sufficient to win at Jeopardy!
- But IBM devoted a large research team to a single problem.

Longer answer: Single paradigm vs. multiple paradigms.

- Cyc is based on a single paradigm: formal logic, deductive reasoning, a very large ontology, and large volumes of data.
- IBM used a team of researchers with a wide range of expertise.
- They started with many independently developed tools and made them interoperate on different aspects of the problem.

Next question: Is it possible to develop Watson-like systems without requiring three dozen PhD researchers?

Diversity of Tools and Techniques

The ability to make tools is a critical sign of intelligence:

- All animals, including humans, are born with a set of built-in tools.
- Birds can't wash dishes for the same reason that humans can't wash dishes with a sewing machine: they have the wrong tools.
- Humans make and use the most elaborate tools, but biologists keep discovering more species that make and use tools.

The role of instinct:

- Birds have an instinct to build nests, beavers have an instinct to build dams, and humans have an instinct to speak a language.
- But the details of the nests, dams, and languages depend on the animals' built-in tools, the environment, learning from parents, and creativity.

For every physical tool or activity, there is a kind of mental tool:

- Minsky's mental agents correspond to the diversity of human activities.
- The diversity of Wittgenstein's language games results from the many ways of using the human vocal tools for talking about the activities.

Designing Hybrid Systems

In his *Society of Mind* and *Emotion Engine*, Minsky proposed a society of heterogeneous, interacting modules or agents.

- Would such an organization enable parallel computation?
- How would the agents communicate and cooperate among themselves?
- What methods of representation and reasoning would they require?
- How could they relate symbols, images, and statistics?
- How could a society of agents produce a unified personality?
- How could they agree on common goals, plans for achieving the goals, and tactical decisions at each step?
- Could psycholinguistics and neuroscience provide some guidance?

Requirements for supporting a society of agents:

- A system of communication and coordination. *
- Methods for sharing and using information in long-term memory. **
- A cognitive cycle of perception, learning, reasoning, and acting.

* J. F. Sowa (2002) Architectures for intelligent systems. <http://www.jfsowa.com/pubs/arch.pdf>

** A. K. Majumdar & J. F. Sowa (2009) Two paradigms are better than one, and multiple paradigms are even better. <http://www.jfsowa.com/pubs/paradigm.pdf>

4. Cycles of Learning and Reasoning

Children learn language by starting with words and patterns of words that are grounded in perception and purposive action.

By trial and error, children and adults revise, extend, and adjust their beliefs to make better predictions about the world:

- **Observations generate low-level facts.**
- **Induction derives general axioms from multiple facts.**
- **A mixture of facts and axioms is an unstructured *knowledge soup*.**
- **Abduction selects facts and axioms to form a hypothesis (theory).**
- **Analogies may relabel a theory of one topic and apply it to another.**
- **Deductions from a theory generate predictions about the world.**
- **Actions test the predictions against reality.**
- **The effects of the actions lead to new observations.**

Cycles within cycles may be traversed at any speed — from seconds to minutes to research projects that take years.

Observing, Learning, Reasoning, Acting

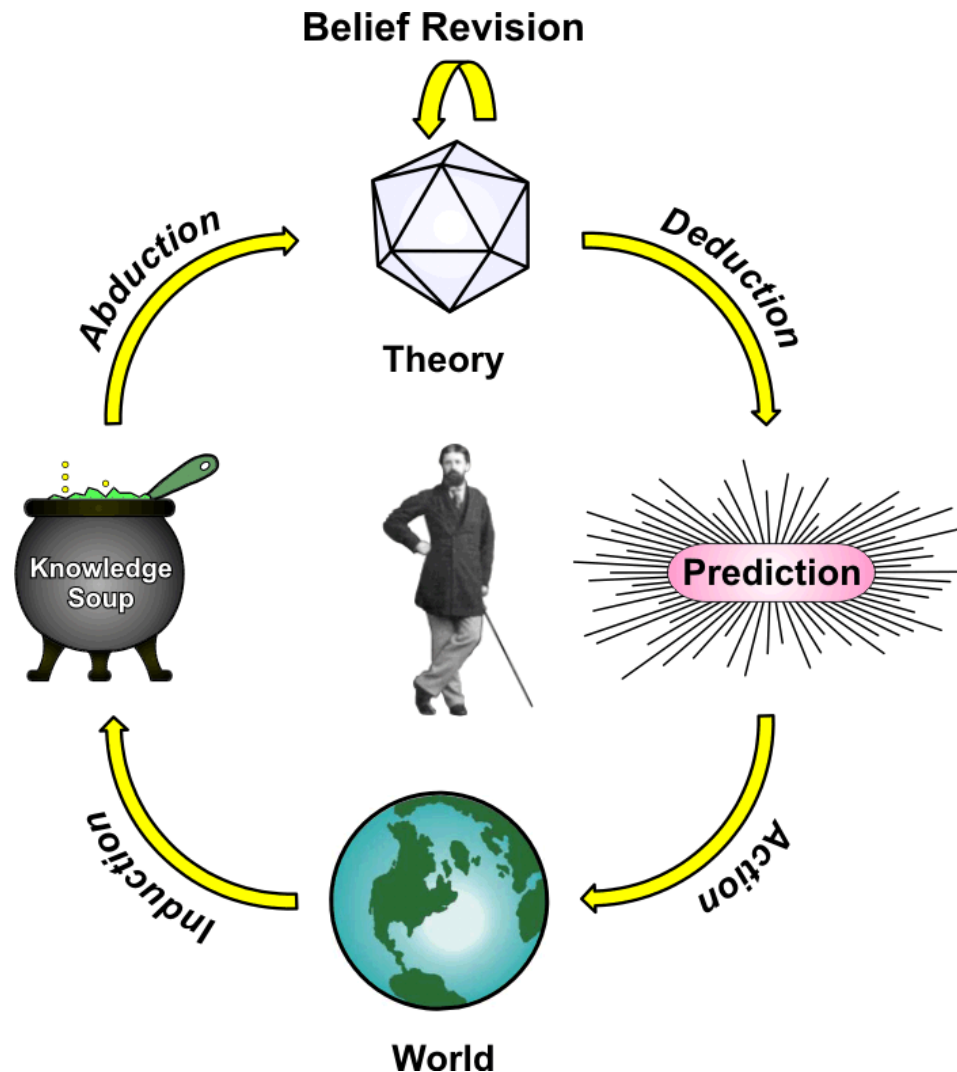

The human cycle, as described by Charles Sanders Peirce. Similar cycles occur in every aspect of life, including science.

Knowledge Soup

A heterogeneous, loosely linked mixture:

- **Fluid, lumpy, and dynamically changing.**
- **Many lumps are or can be structured in a computable form.**
- **But they may be inconsistent or incompatible with one another.**

In anybody's head, knowledge soup is

- **The totality of everything in memory.**

In the WWW, knowledge soup is

- **The totality of everything people downloaded from their heads, recorded automatically, or derived by any computable method.**

Linked Open Data is good for finding and classifying anything in the soup – whether loose items or structured lumps.

But understanding the contents of the LOD poses the same challenge as understanding natural language.

Human Learning Requires Language

People use language to express every aspect of life.

The cognitive cycle integrates all aspects, including language:

- **New data (experiences) accumulate from observations in life.**
- **Statistical methods are useful for finding generalizations.**
- **But those generalizations must be integrated with previous knowledge.**
- **Routine abduction may use statistics to select patterns from the soup.**
- **But creative abduction is necessary to invent new patterns.**
- **Belief revision integrates various patterns into larger, better structured patterns called hypotheses or theories.**
- **Deduction generates predictions from the theories.**
- **Actions in and on the world test the predictions.**
- **New observations provide supervision (rewards and punishments).**

Language is essential for expressing novel patterns and for learning the novel patterns discovered by other people.

Boyd's OODA Loop

John Boyd drew a four-step diagram for training fighter pilots to observe and respond rapidly.

The first two steps – Observe and Orient – involve the occipital, parietal, and temporal lobes.

The next two steps – Decide and Act – involve the frontal lobes for reasoning and motor control.

The four steps and the associated brain areas:

1. **Observe:** Visual input goes to the primary visual cortex (occipital lobes), but object recognition and naming involve the temporal lobes.
2. **Orient:** Parietal lobes relate vision, touch, and sound in “cognitive maps.”
3. **Decide:** Reasoning is under the control of the frontal lobes, but other areas store the “knowledge soup” and the “mental models.”
4. **Act:** “Action schemata” are patterns in the premotor cortex of the frontal lobes. Signals from the motor cortex go to the muscles.

Each step must be traversed in milliseconds for rapid response.

The time constraints require high-speed matching of overlearned patterns.

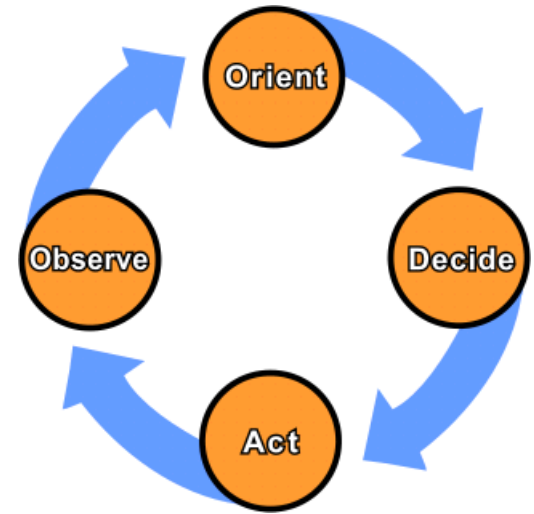

Extended OODA Loop

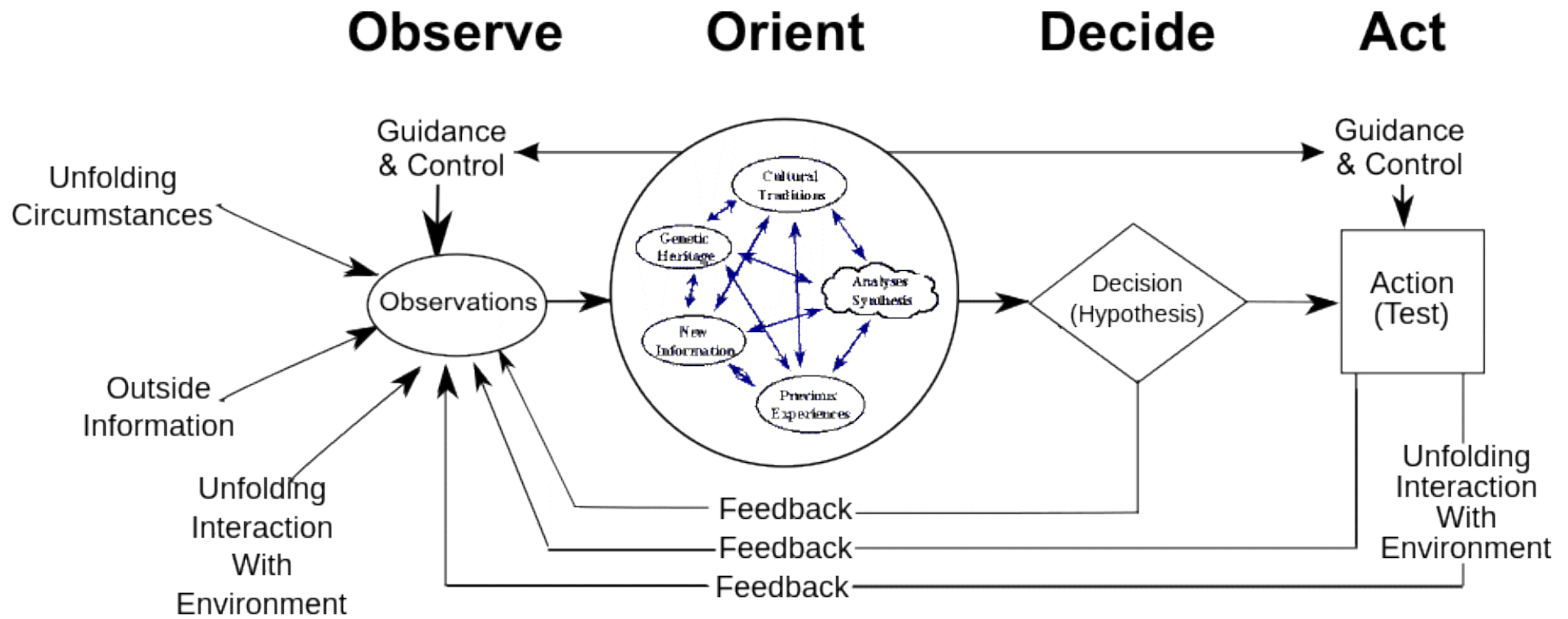

Over the years, Boyd added more detail to the OODA Loop. He applied it to decision-making processes of any kind. Both versions are consistent with Peirce's cycle.

Ohlsson's Deep Learning Cycle

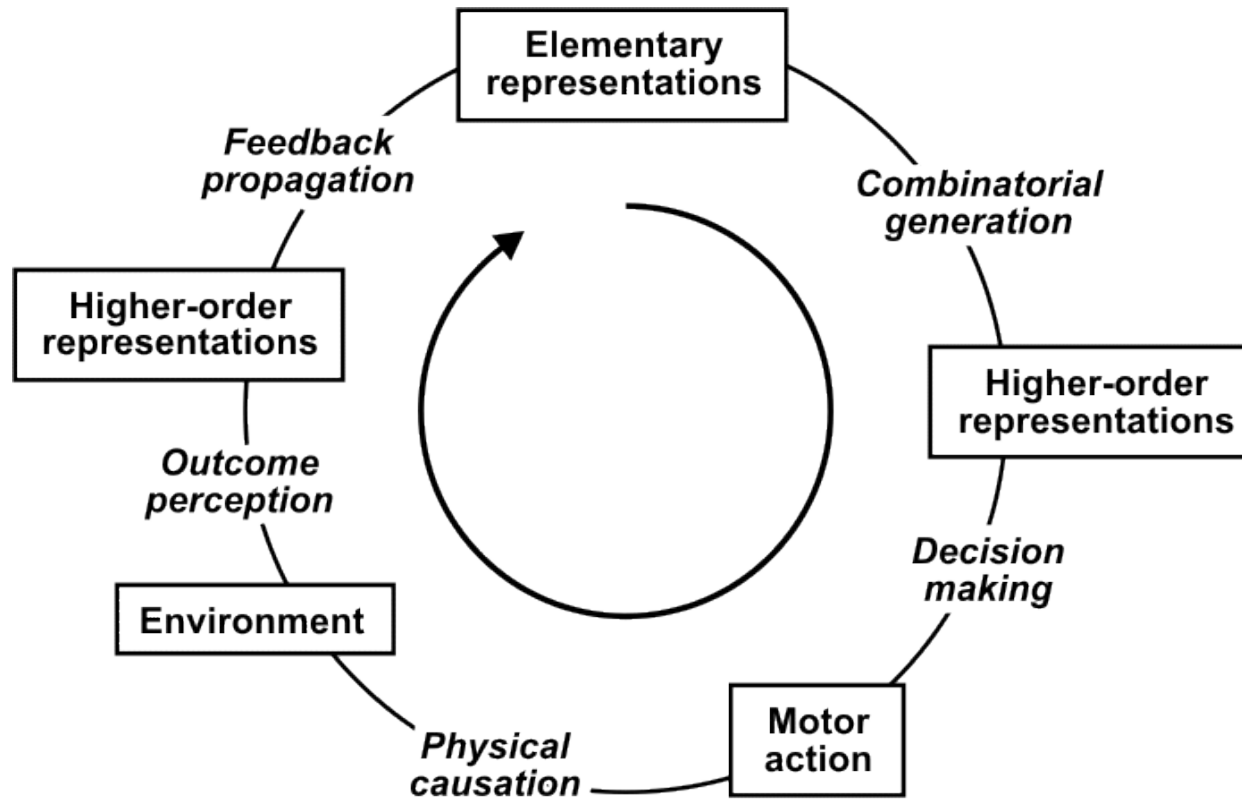

Deep learning is non-monotonic cognitive change: *

- Create novel structures that are incompatible with previous versions.
- Adapt cognitive skills to changing circumstances.
- Test those skills by action upon the environment.

* Stellan Ohlsson (2011) *Deep Learning: How the Mind Overrides Experience*, Cambridge: University Press.

Albus Cognitive Architecture

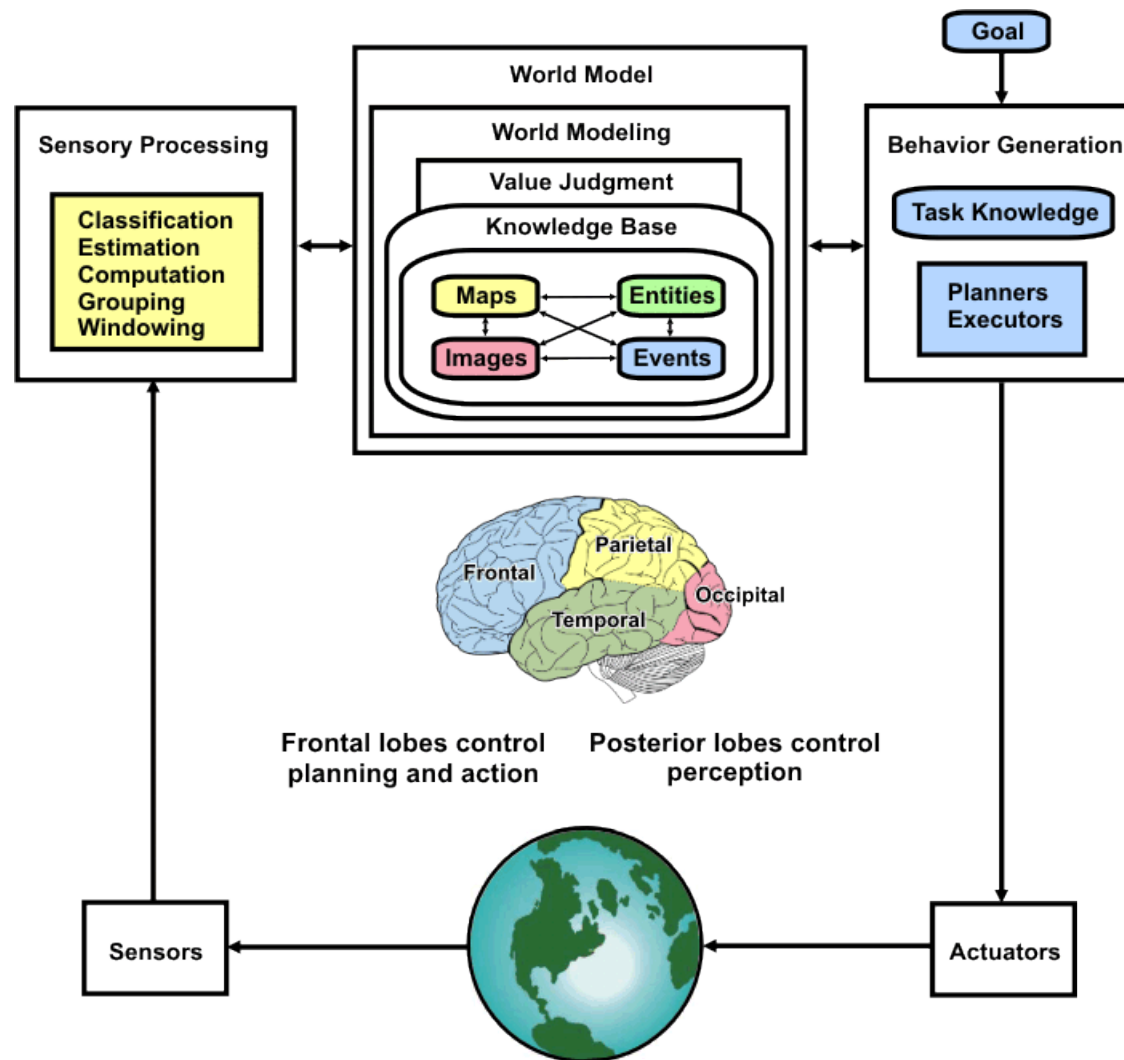

A diagram that resembles the cycles by Peirce, Boyd, and Ohlsson.

See Albus (2010), <http://www.james-albus.org/docs/ModelofComputation.pdf>

Real-Time Control System (RCS)

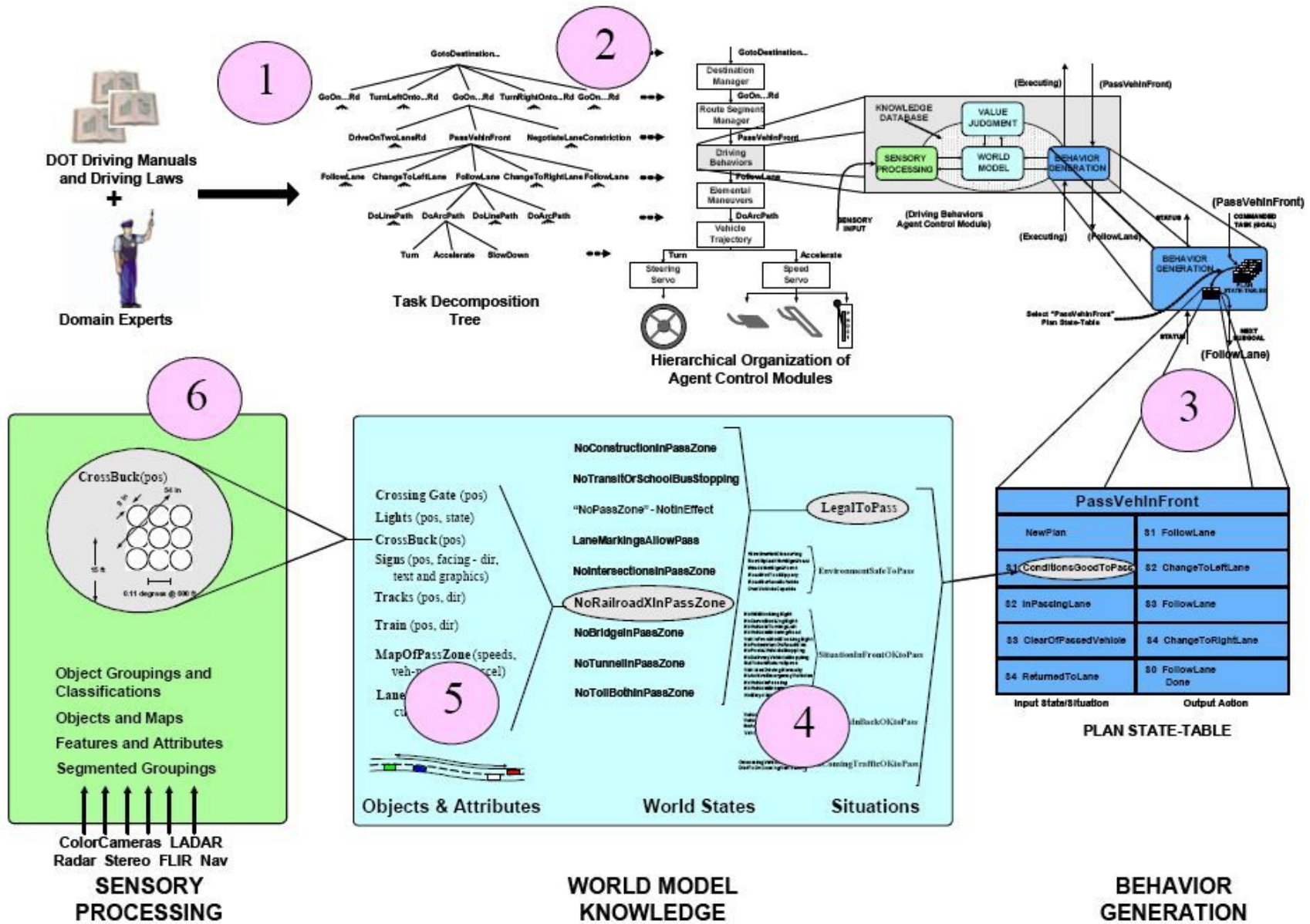

Designed by Albus and colleagues: http://en.wikipedia.org/wiki/Real-time_Control_System

RCS Computational Node

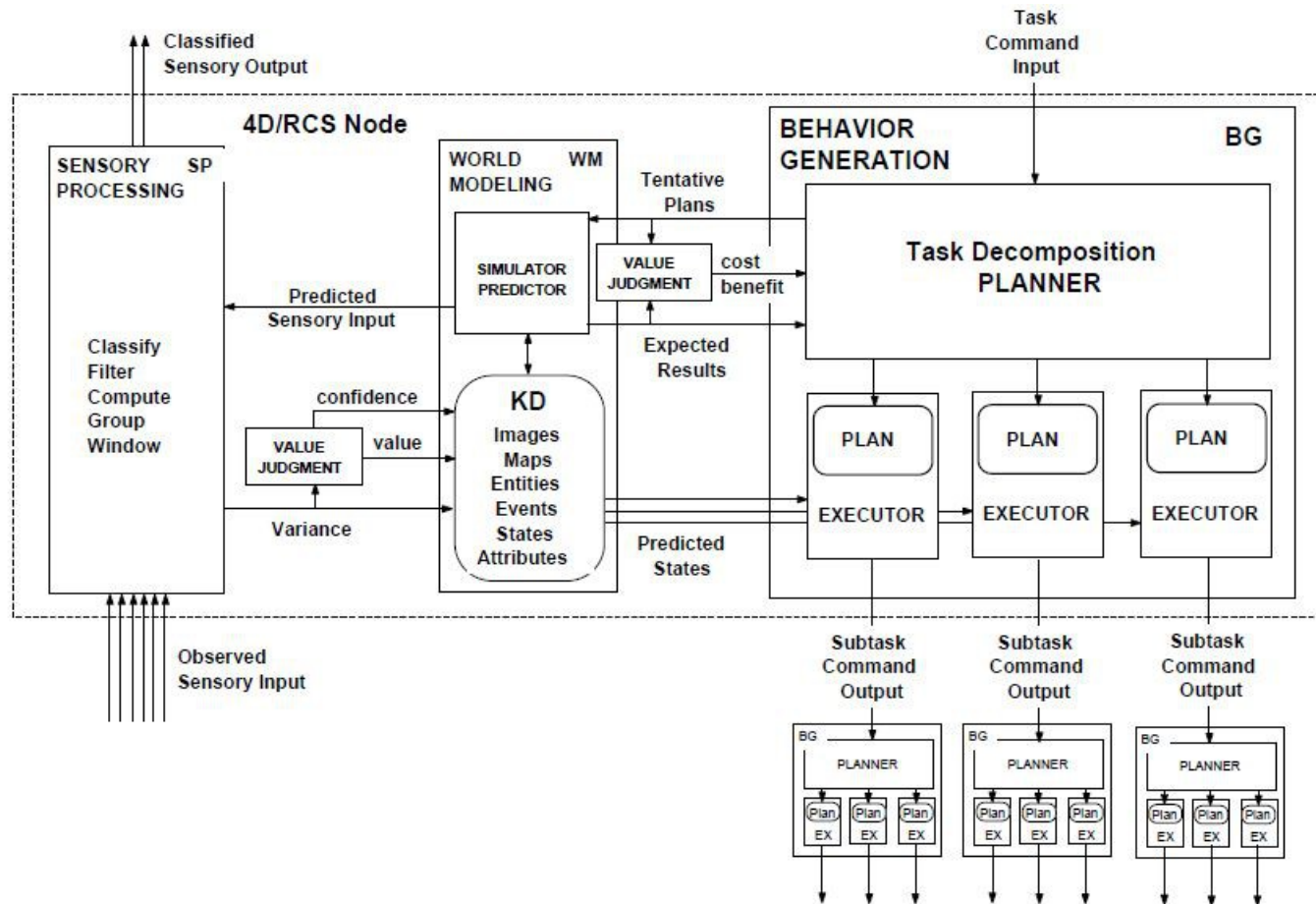

A hierarchy of computational nodes do the planning for tasks and subtasks.

Behavior generation (BG) uses a world model (WM) constructed from sensory processing (SP) and a knowledge database (KD). Value judgment (VJ) uses a cost-benefit analysis to evaluate plans in terms of expected results.

Implementing the Cycles

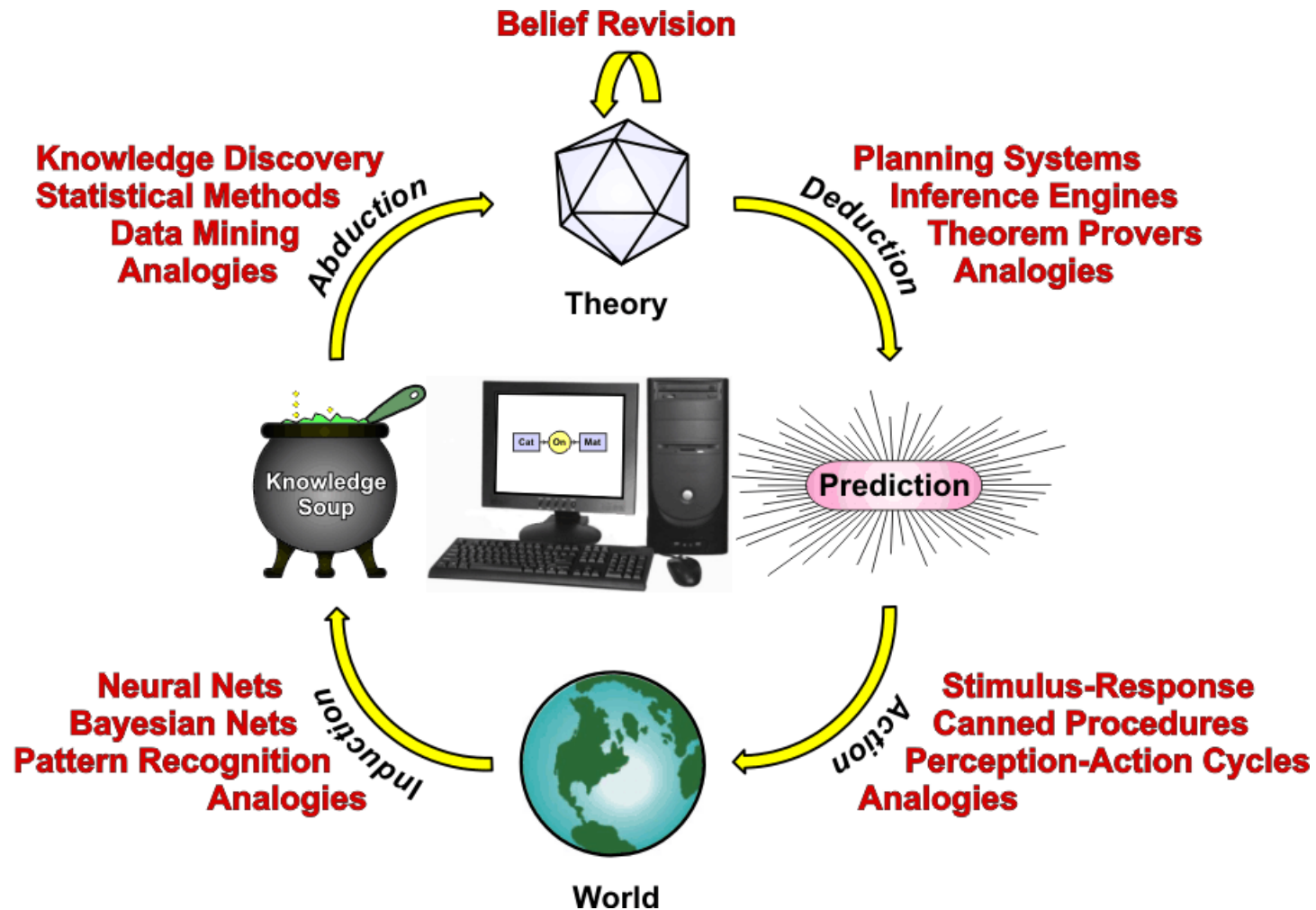

Computational methods for learning, reasoning, and acting.

Creative Abduction

Creativity, by definition, introduces something totally new.

Observation and abduction are the sources of novelty:

- **Observation is the ultimate source of all information.**
- **Routine observations classify new information in familiar patterns.**
- **Induction generalizes multiple observations by simplifying patterns.**
- **Routine abduction makes selections from familiar patterns.**
- **Belief revision modifies a theory by adding and deleting patterns.**
- **Deduction uses systematic rules for combining and relating patterns.**
- **But creative abduction (invention) introduces novel patterns.**

For young children, almost everything is unfamiliar.

- **They are the most creative people on earth.**

For most adults, most things are familiar.

- **They rarely feel the need to create new patterns.**
- **But they can learn new patterns created by other people.**

Future Directions for AI

Language is as general and flexible as human thought.

It requires an interpreter — human or robot — to relate a text to the current task, context, and goals.

- **That process changes the interpreter's background knowledge.**
- **But the kind of change depends critically on the task and the interpreter's goals and background knowledge.**
- **No two interpreters understand a text in exactly the same way.**
- **With different contexts, goals, or knowledge, an interpreter may understand the same text in different ways at different times.**

For intelligent systems, the cognitive cycle is more fundamental than any particular notation or algorithm.

By integrating perception, learning, reasoning, and action, the cycle can reinvigorate AI research and development.